

# 6N137

## Super High Speed Response \*OPIC Photocoupler

### ■ Features

1. Super high speed response  
( $t_{PHL}$ ,  $t_{PLH}$  : TYP. 45ns at  $R_L=350\Omega$ )
2. Isolation voltage between input and output  
Viso(rms) : 2.5kV
3. Instantaneous common mode rejection voltage  
 $CM_H$  : TYP. 500V/ $\mu$ s
4. LSTTL and TTL compatible output
5. Recognized by UL, file No. E64380

### ■ Applications

1. High speed interfaces for computer peripherals, microcomputer systems
2. High speed line receivers
3. Noise reduction
4. Interfaces for data transmission equipment

### ■ Outline Dimensions

(Unit : mm)

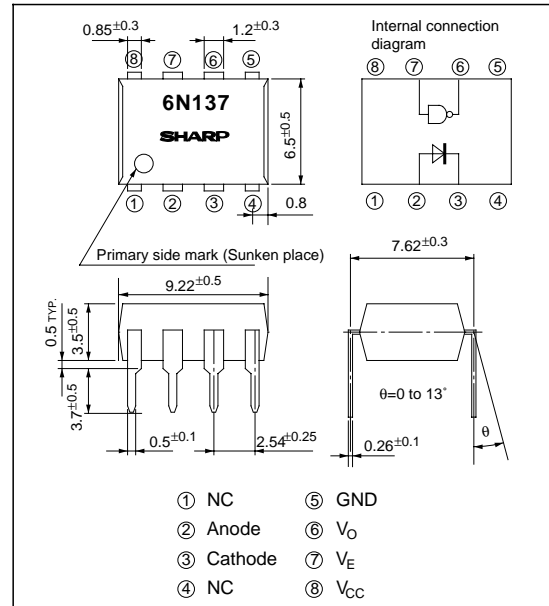

\* "OPIC" (Optical IC) is a trademark of the SHARP Corporation.  
An OPIC consists of a light-detecting element and signal-processing circuit integrated onto a single chip.

### ■ Absolute Maximum Ratings

(Ta=25°C)

	Parameter	Symbol	Rating	Unit
Input	*1 Forward current	$I_F$	20	mA
	*2 Peak forward current	$I_{FM}$	40	mA
	Reverse voltage	$V_R$	5	V
Output	*3 Supply voltage	$V_{CC}$	7	V
	*4 Enable voltage	$C_E$	5.5	V
	Output voltage	$V_O$	7	V
	Output current	$I_O$	50	mA
	Output collector power dissipation	$P_C$	85	mW
	*5 Isolation voltage	$V_{iso(rms)}$	2.5	kV
	Operating temperature	$T_{opr}$	0 to +70	°C
	Storage temperature	$T_{stg}$	-55 to +125	°C
	*6 Soldering temperature	$T_{sol}$	260	°C

\*1 Ta=0 to 70°C

\*2 Pulse width≤1ms

\*3 For 1 minute MAX.

\*4 Not exceed 500mV or more than supply voltage ( $V_{CC}$ )

\*5 AC for 1 minute, 40 to 60% RH

Apply the specific voltage between all the input electrode pins connected together and all the output electrode pins connected together.

\*6 2mm or more away from the lead base for 10 seconds

Notice In the absence of confirmation by device specification sheets, SHARP takes no responsibility for any defects that may occur in equipment using any SHARP devices shown in catalogs, data books, etc. Contact SHARP in order to obtain the latest device specification sheets before using any SHARP device.  
Internet Internet address for Electronic Components Group <http://www.sharp.co.jp/ecg/>

## ■ Electro-optical Characteristics

(Ta=0 to +70°C unless otherwise specified)

Parameter	Symbol	Conditions	MIN.	TYP.	MAX.	Unit
Logic (1) output current	I <sub>OH</sub>	V <sub>CC</sub> =5.5V, V <sub>O</sub> =5.5V, I <sub>F</sub> =250 μA, V <sub>E</sub> =2.0V	–	2	250	μA
Logic (0) output voltage	V <sub>OL</sub>	V <sub>CC</sub> =5.5V, I <sub>F</sub> =5mA, V <sub>EH</sub> =2.0V, I <sub>OL</sub> (Sinking)=13mA	–	0.4	0.6	V
Logic (1) enable current	I <sub>EH</sub>	V <sub>CC</sub> =5.5V, V <sub>E</sub> =2.0V	–	–0.8	–	mA
Logic (0) enable current	I <sub>EL</sub>	V <sub>CC</sub> =5.5V, V <sub>E</sub> =0.5V	–	–1.2	–2.0	mA
Logic (1) supply current	I <sub>CCH</sub>	V <sub>CC</sub> =5.5V, I <sub>F</sub> =0mA, V <sub>E</sub> =0.5V	–	7	15	mA
Logic (0) supply current	I <sub>CCL</sub>	V <sub>CC</sub> =5.5V, I <sub>F</sub> =10mA, V <sub>E</sub> =0.5V	–	13	18	mA
<sup>*7</sup> Leak current	I <sub>LO</sub>	45%RH, Ta=25°C, t=5s, V <sub>LO</sub> =3.0kV DC	–	–	1.0	μA
<sup>*7</sup> Isolation resistance (input-output)	R <sub>LO</sub>	V <sub>LO</sub> =500V, Ta=25°C	–	1×10 <sup>12</sup>	–	Ω
<sup>*7</sup> Capacitance (input-output)	C <sub>LO</sub>	f=1MHz, Ta=25°C	–	0.6	–	pF
<sup>*8</sup> Input forward voltage	V <sub>F</sub>	I <sub>F</sub> =10mA, Ta=25°C	–	1.6	1.75	V
Input reverse voltage	BV <sub>R</sub>	I <sub>R</sub> =10μA, Ta=25°C	5	–	–	V
Input capacitance	C <sub>IN</sub>	V <sub>F</sub> =0, f=1MHz	–	60	–	pF

<sup>\*7</sup> Measured as 2-pin element. Connect pins 2 and 3 connect pins 5,6,7 and 8.

<sup>\*8</sup> At I<sub>F</sub>=10mA, V<sub>F</sub> decreases at the rate of 1.6mV/°C if the temperature goes up.

## ■ Switching Characteristics

Parameter	Symbol	Conditions	MIN.	TYP.	MAX.	Unit
<sup>*9</sup> Propagation delay time Output (0) → (1)	t <sub>PLH</sub>	Ta=25°C, R <sub>L</sub> =350Ω, C <sub>L</sub> =15pF, I <sub>F</sub> =7.5mA	–	45	75	ns
<sup>*9</sup> Propagation delay time Output (1) → (0)	t <sub>PHL</sub>	Ta=25°C, R <sub>L</sub> =350Ω, C <sub>L</sub> =15pF, I <sub>F</sub> =7.5mA	–	45	75	ns
Output rise-fall time (10 to 90%)	t <sub>r</sub> , t <sub>f</sub>	R <sub>L</sub> =350Ω, C <sub>L</sub> =15pF, I <sub>F</sub> =7.5mA	–	20, 30	–	ns
<sup>*10</sup> Enable propagation delay time (1) → (0)	t <sub>ELH</sub>	R <sub>L</sub> =350Ω, C <sub>L</sub> =15pF, I <sub>F</sub> =7.5mA, V <sub>EH</sub> =3.0V, V <sub>EL</sub> =0.5V	–	40	–	ns
<sup>*10</sup> Enable propagation delay time (0) → (1)	t <sub>EHL</sub>	R <sub>L</sub> =350Ω, C <sub>L</sub> =15pF, I <sub>F</sub> =7.5mA, V <sub>EH</sub> =3.0V, V <sub>EL</sub> =0.5V	–	15	–	ns
<sup>*11</sup> Instantaneous common mode rejection voltage "Output (1)"	CM <sub>H</sub>	V <sub>CM</sub> =10V, R <sub>L</sub> =350Ω, V <sub>O</sub> (min.)=2V, I <sub>F</sub> =0mA	–	500	–	V/μs
<sup>*11</sup> Instantaneous common mode rejection voltage "Output (0)"	CM <sub>L</sub>	V <sub>CM</sub> =10V, R <sub>L</sub> =350Ω, V <sub>O</sub> (max.)=0.8V, I <sub>F</sub> =5mA	–	–500	–	V/μs

<sup>\*9</sup> Refer to the Fig. 1.

<sup>\*10</sup> Refer to the Fig. 2.

<sup>\*11</sup> CM<sub>H</sub> represents a common mode voltage variation that can hold the output above (1) level (V<sub>O</sub>>2.0V).

CM<sub>L</sub> represents a common mode voltage variation that can hold the output above (0) level (V<sub>O</sub><0.8V)

Note) Typical values are all at V<sub>CC</sub>=5V, Ta=25°C

## ■ Recommended Operating Conditions

Parameter	Symbol	MIN.	MAX.	Unit
Low level input current	I <sub>FL</sub>	0	250	μA
High level input current	I <sub>FH</sub>	7.0	15	mA
High level enable voltage	V <sub>EH</sub>	2.0	V <sub>CC</sub>	V
Low level enable voltage	V <sub>EL</sub>	0	0.8	V
Supply voltage	V <sub>CC</sub>	4.5	5.5	V
Fanout (TTL load)	N	–	8	–
Operating temperature	T <sub>opr</sub>	0	70	°C

- No necessary external pull-up resistor to hold enable input at high level.
- Connect a ceramic by-pass capacitor (0.01 to 0.1μF) between V<sub>CC</sub> and GND at the position within 1cm from pin.

## Circuit Block Diagram

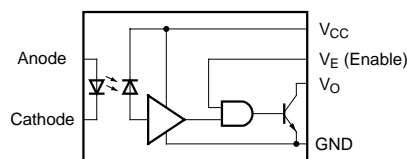

## Truth Table

Input	Enable	Output
H	H	L
L	H	H
H	L	H
L	L	H

L : Logic (0) H : Logic (1)

Fig.1 Test Circuit for Propagation Delay Time

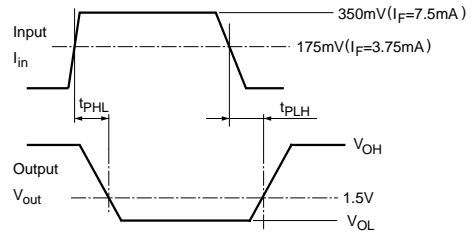
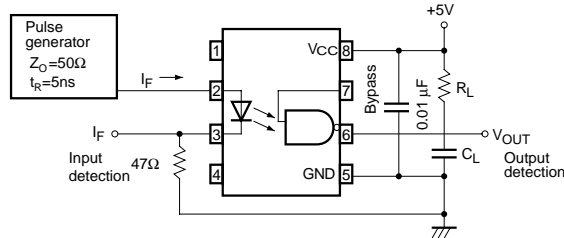

Fig.2 Test Circuit for Enable Propagation Delay Time

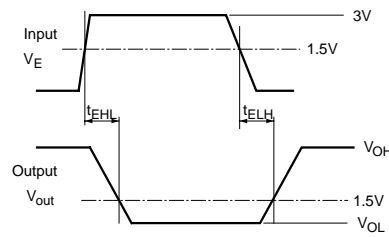
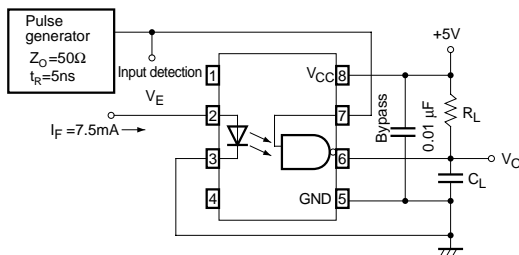

Fig.3 Test Circuit for Instantaneous Common Mode Rejection Voltage

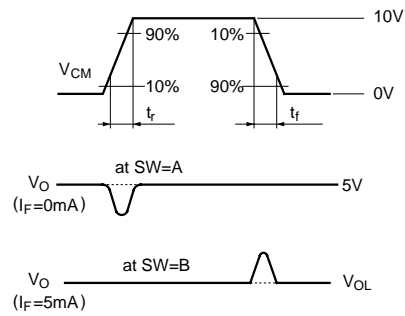
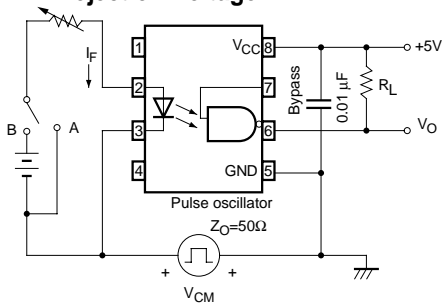

Fig. 4 Output Collector Power Dissipation vs. Ambient Temperature

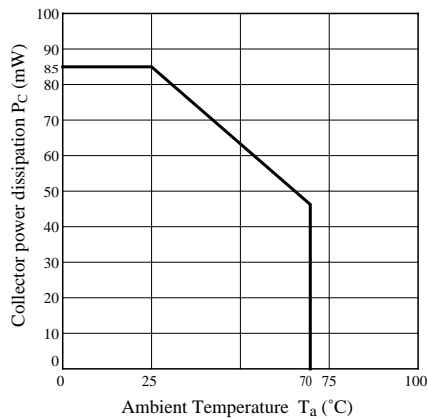
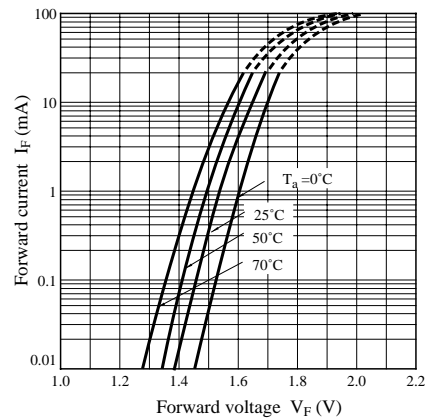
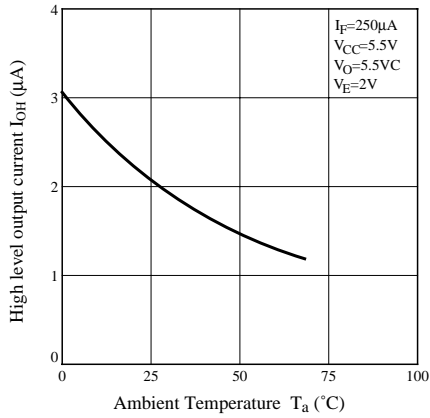

Fig. 5 Forward Current vs. Forward Voltage



**Fig. 6 High Level Output Current vs. Ambient Temperature**



**Fig. 7 Low Level Output Voltage vs. Ambient Temperature**

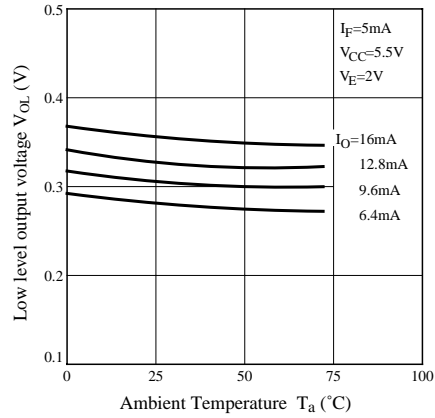

**Fig. 8-a Output Voltage vs. Forward Current**

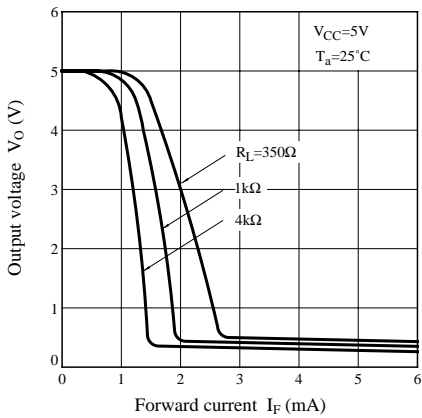

**Fig. 8-b Output Voltage vs. Forward Current (Ambient Temp. Characteristics)**

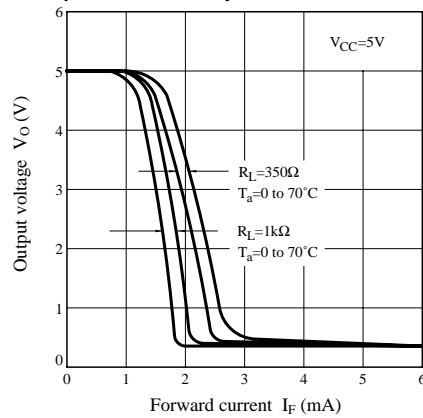

**Fig. 9 Propagation Delay Time vs. Forward Current**

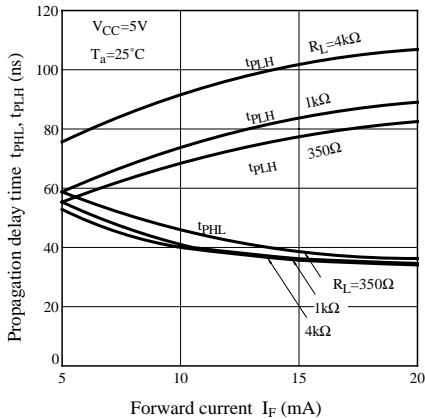

**Fig. 10 Propagation Delay Time vs. Ambient Temperature**

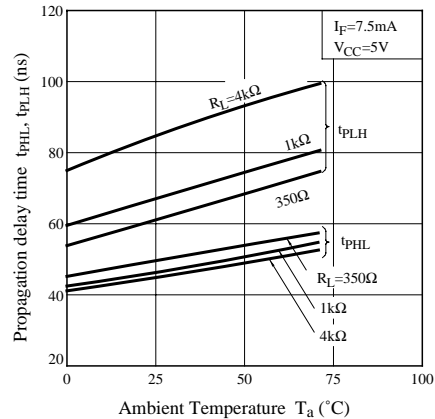

**Fig. 11 Rise Time, Fall Time vs. Ambient Temperature**

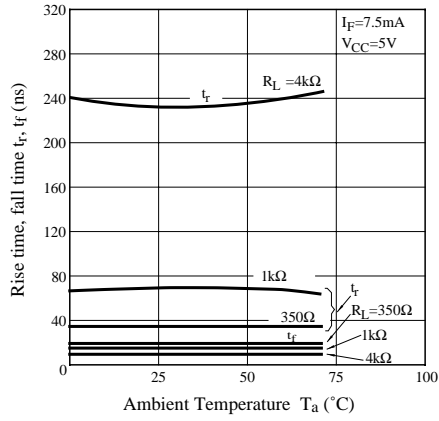

**Fig. 12 Enable Propagation Time vs. Ambient Temperature**

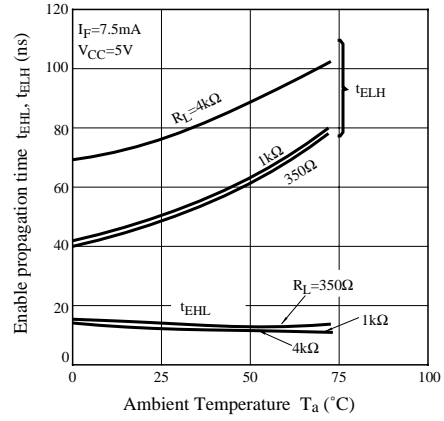

**■ Precaution for Use**

- (1) Handle this product the same as with other integrated circuits against static electricity.

### NOTICE

- The circuit application examples in this publication are provided to explain representative applications of SHARP devices and are not intended to guarantee any circuit design or license any intellectual property rights. SHARP takes no responsibility for any problems related to any intellectual property right of a third party resulting from the use of SHARP's devices.
- Contact SHARP in order to obtain the latest device specification sheets before using any SHARP device. SHARP reserves the right to make changes in the specifications, characteristics, data, materials, structure, and other contents described herein at any time without notice in order to improve design or reliability. Manufacturing locations are also subject to change without notice.
- Observe the following points when using any devices in this publication. SHARP takes no responsibility for damage caused by improper use of the devices which does not meet the conditions and absolute maximum ratings to be used specified in the relevant specification sheet nor meet the following conditions:
  - (i) The devices in this publication are designed for use in general electronic equipment designs such as:
    - Personal computers
    - Office automation equipment
    - Telecommunication equipment [terminal]
    - Test and measurement equipment
    - Industrial control
    - Audio visual equipment
    - Consumer electronics
  - (ii) Measures such as fail-safe function and redundant design should be taken to ensure reliability and safety when SHARP devices are used for or in connection with equipment that requires higher reliability such as:
    - Transportation control and safety equipment (i.e., aircraft, trains, automobiles, etc.)
    - Traffic signals
    - Gas leakage sensor breakers
    - Alarm equipment
    - Various safety devices, etc.
  - (iii) SHARP devices shall not be used for or in connection with equipment that requires an extremely high level of reliability and safety such as:
    - Space applications
    - Telecommunication equipment [trunk lines]
    - Nuclear power control equipment
    - Medical and other life support equipment (e.g., scuba).
- Contact a SHARP representative in advance when intending to use SHARP devices for any "specific" applications other than those recommended by SHARP or when it is unclear which category mentioned above controls the intended use.
- If the SHARP devices listed in this publication fall within the scope of strategic products described in the Foreign Exchange and Foreign Trade Control Law of Japan, it is necessary to obtain approval to export such SHARP devices.
- This publication is the proprietary product of SHARP and is copyrighted, with all rights reserved. Under the copyright laws, no part of this publication may be reproduced or transmitted in any form or by any means, electronic or mechanical, for any purpose, in whole or in part, without the express written permission of SHARP. Express written permission is also required before any use of this publication may be made by a third party.
- Contact and consult with a SHARP representative if there are any questions about the contents of this publication.